

Ментальная арифметика

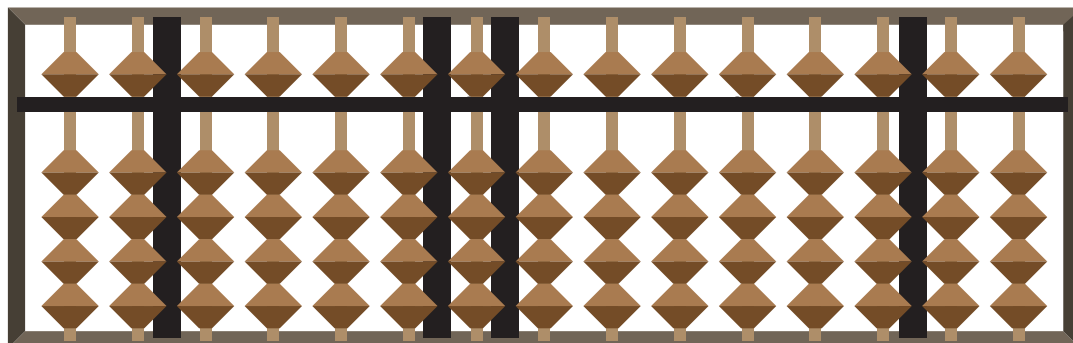

Дополнительные
материалы

Рисуем двумя
руками



ЛЕВАЯ

ПРАВАЯ

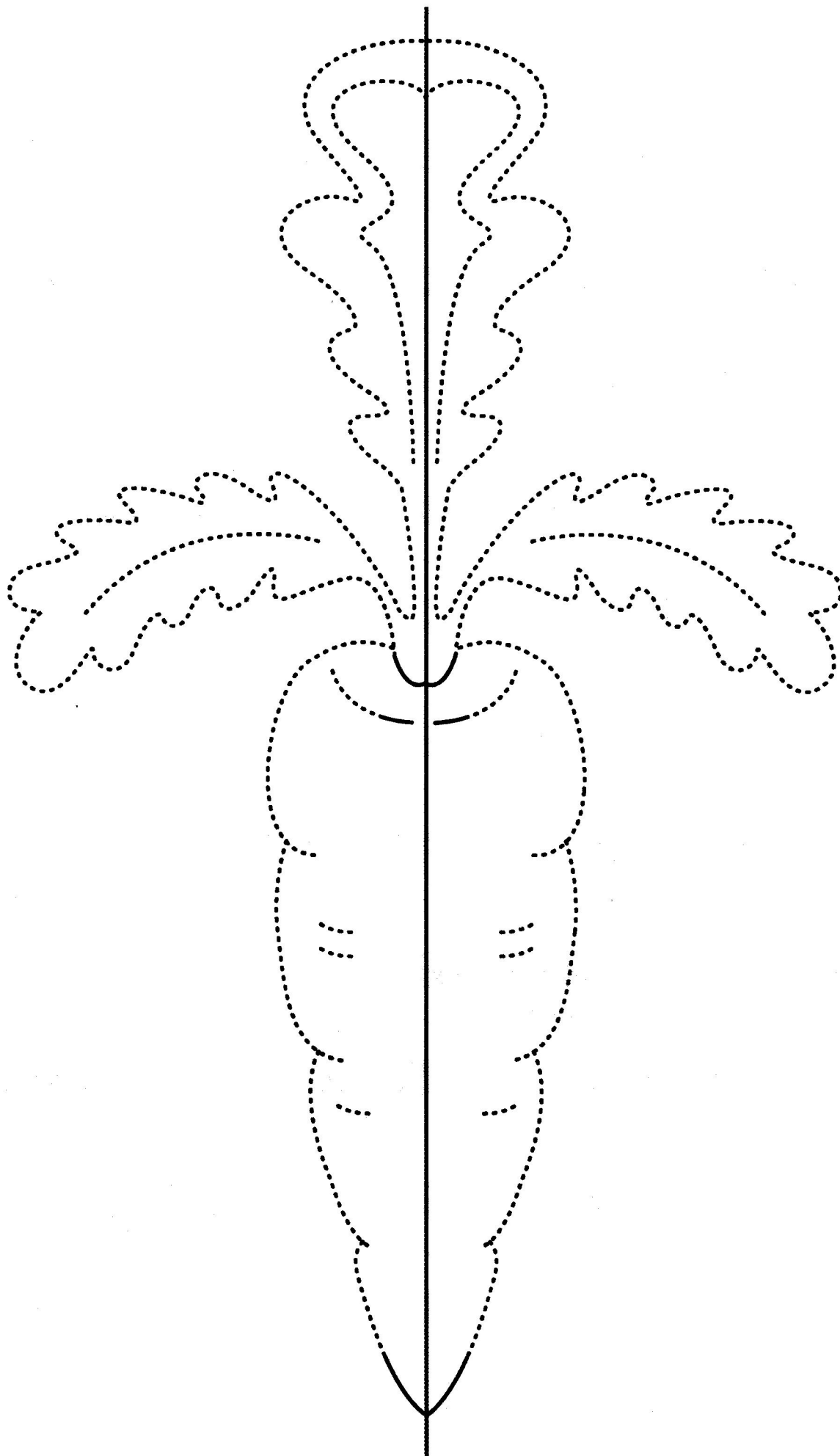

ЛЕВАЯ

ПРАВАЯ

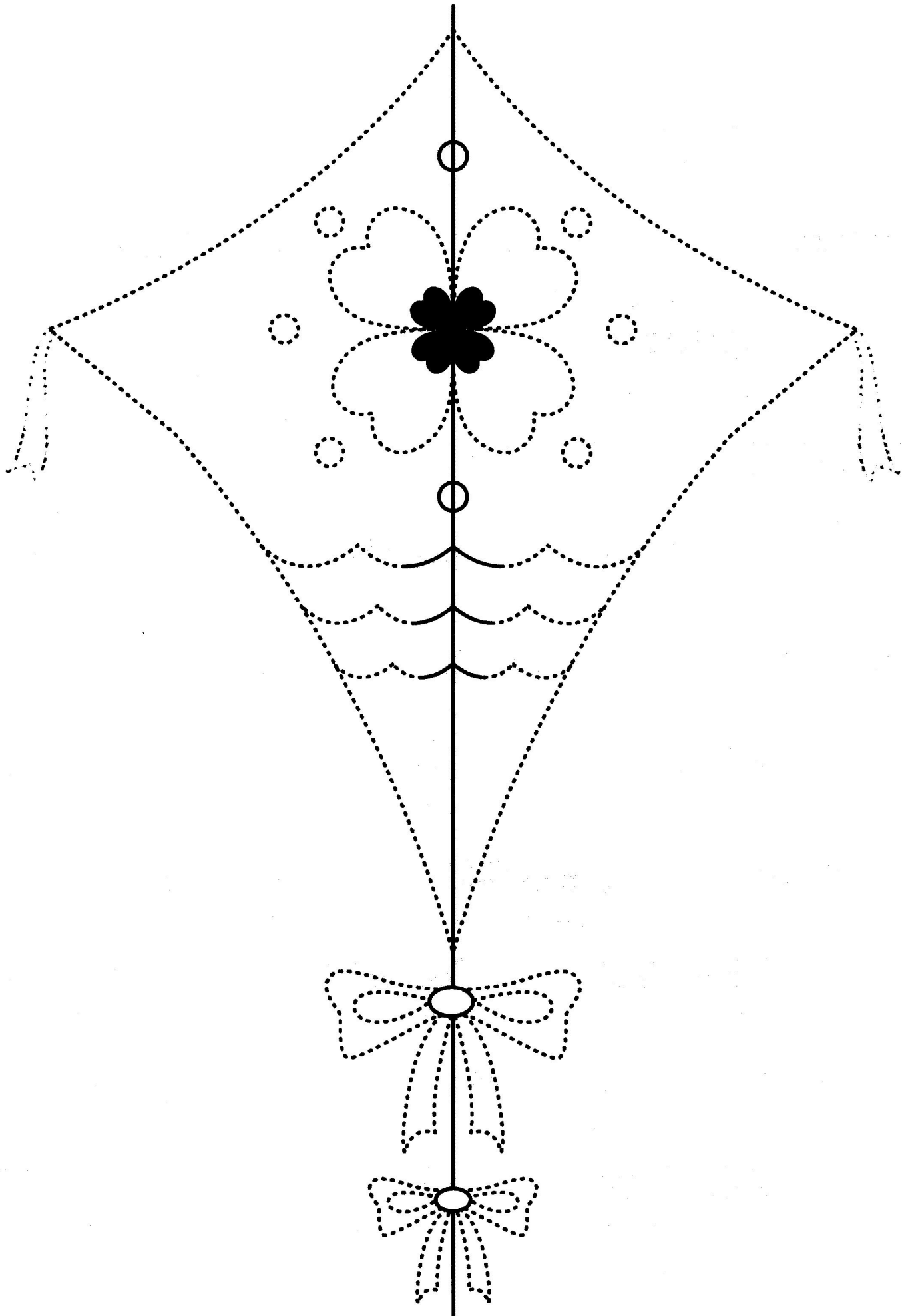

ЛЕВАЯ

ПРАВАЯ

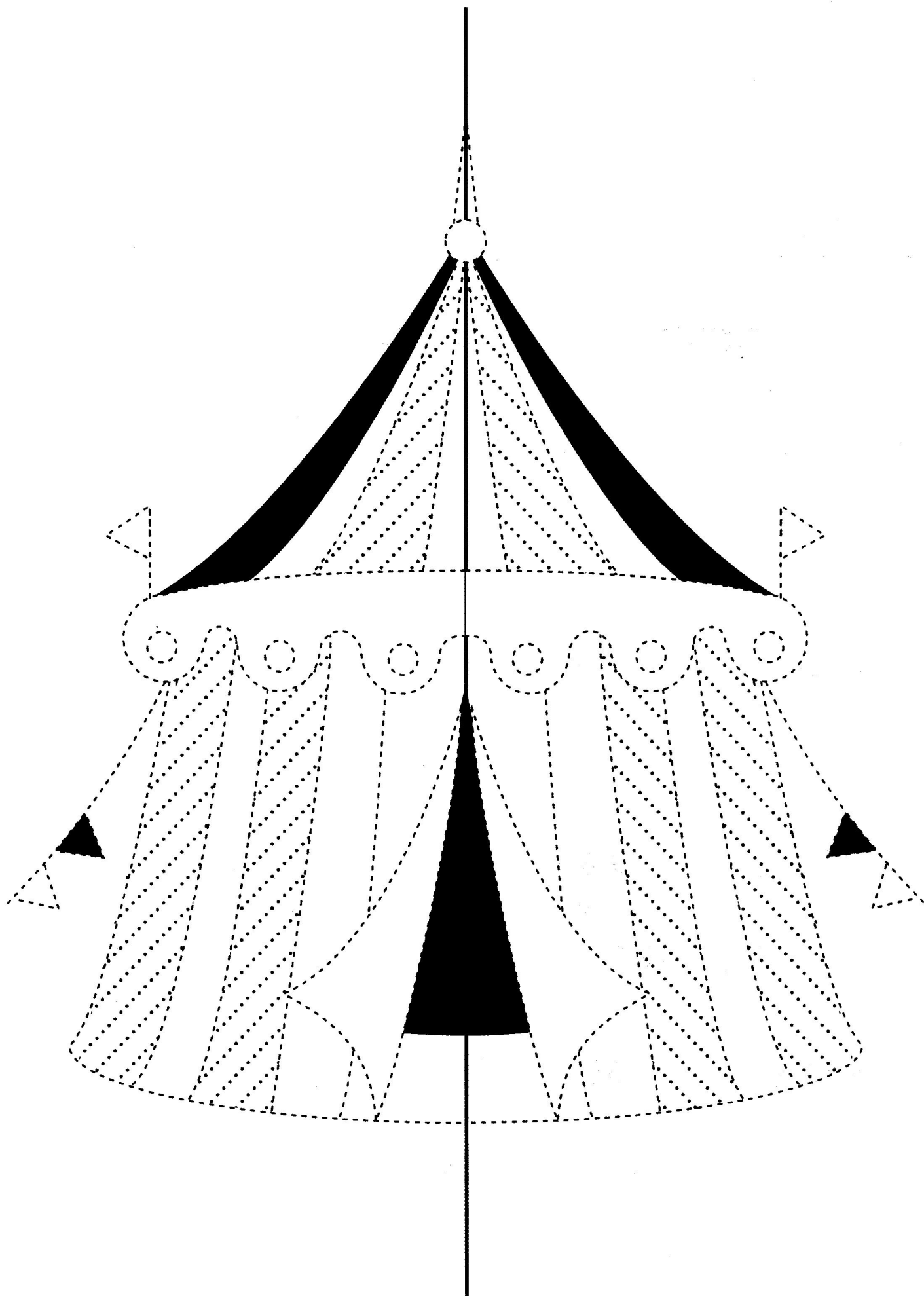

ЛЕВАЯ

ПРАВАЯ

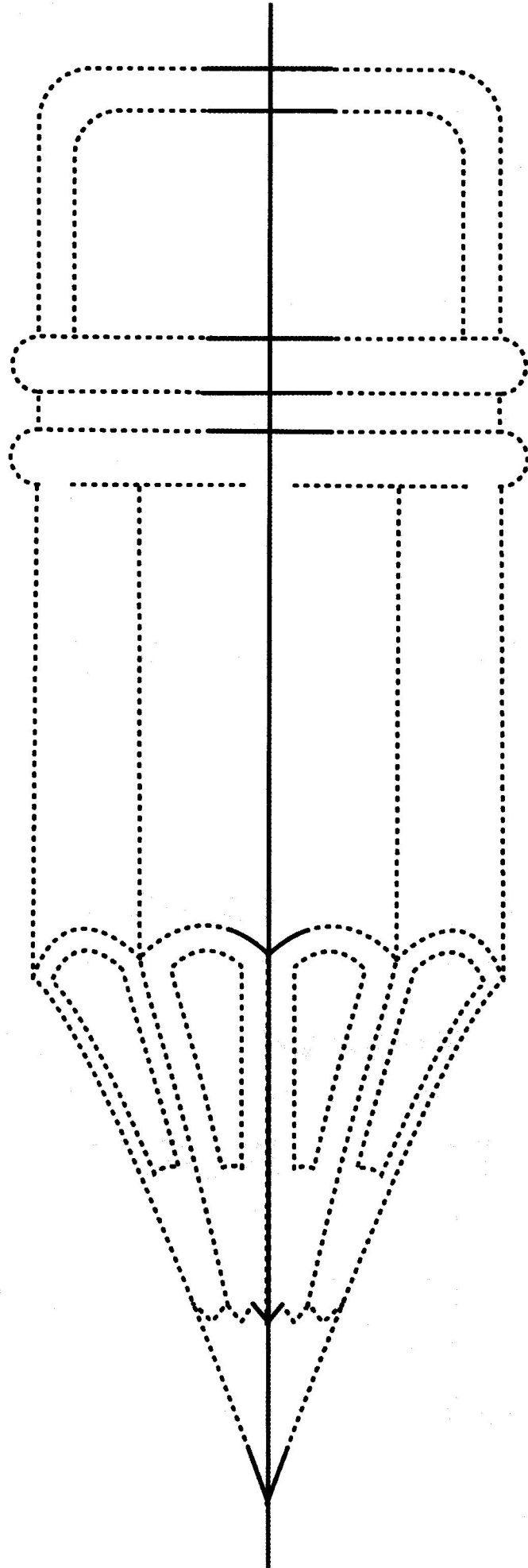

ЛЕВАЯ

ПРАВАЯ

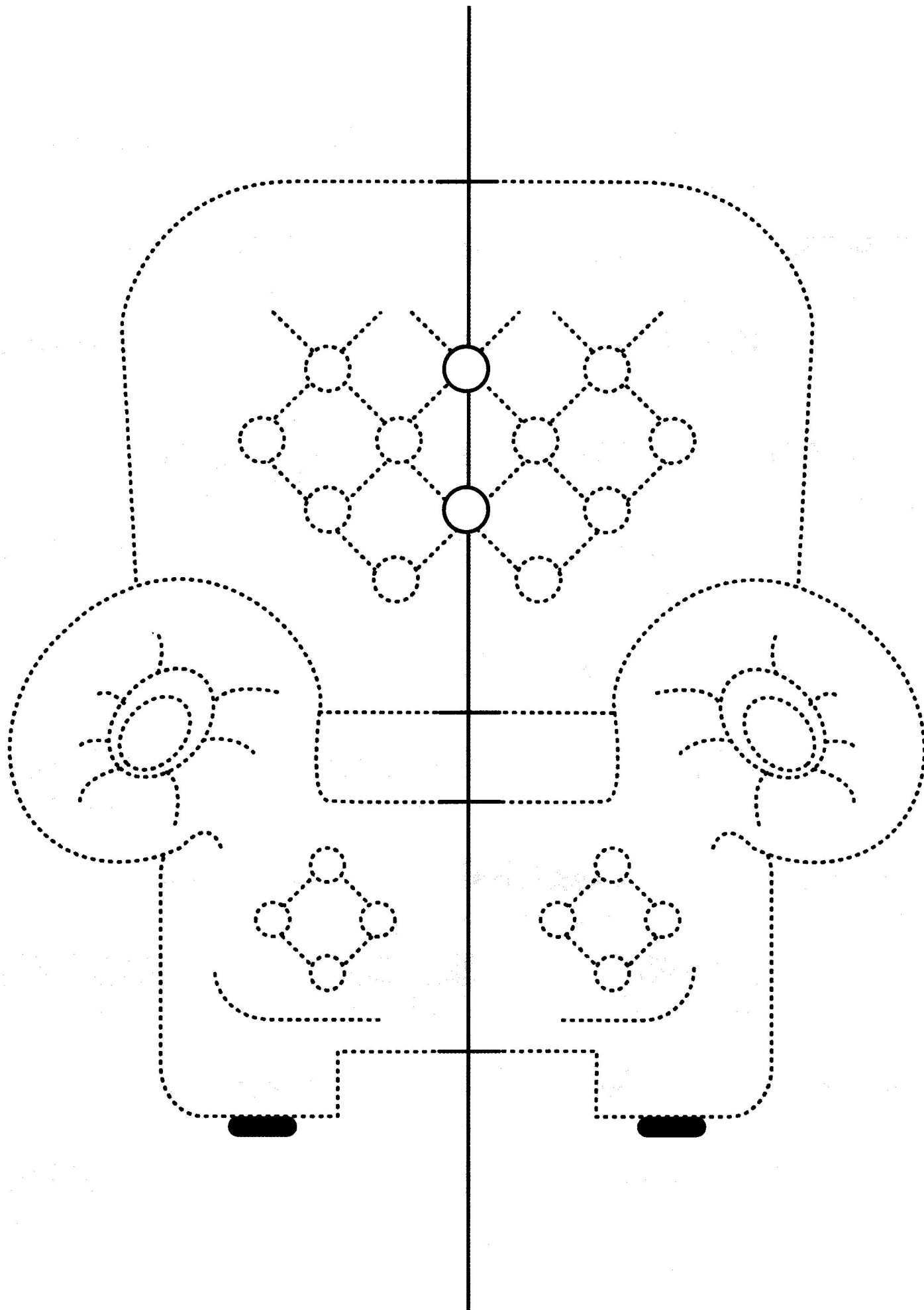

ЛЕВАЯ

ПРАВАЯ

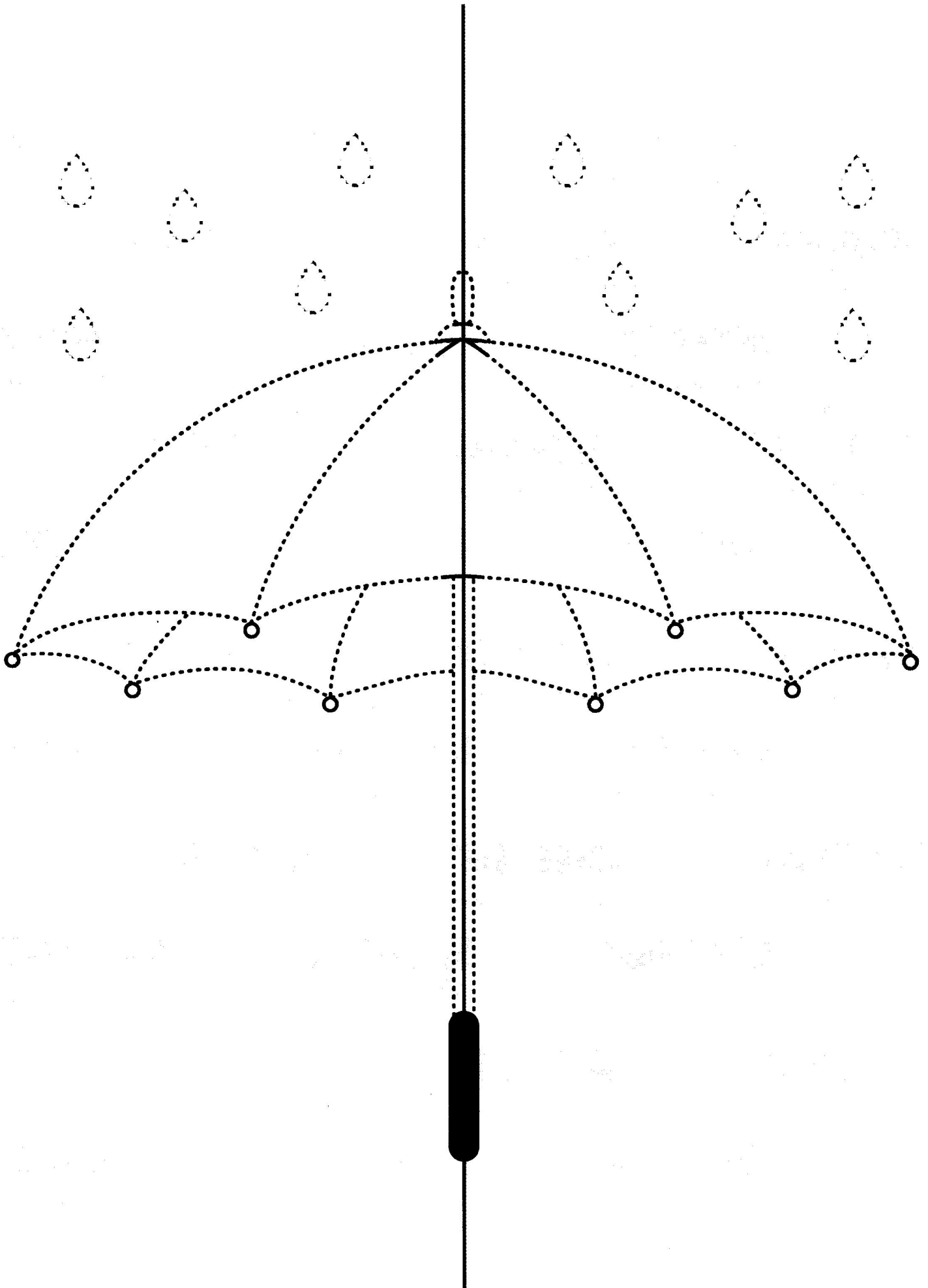

ЛЕВАЯ

ПРАВАЯ

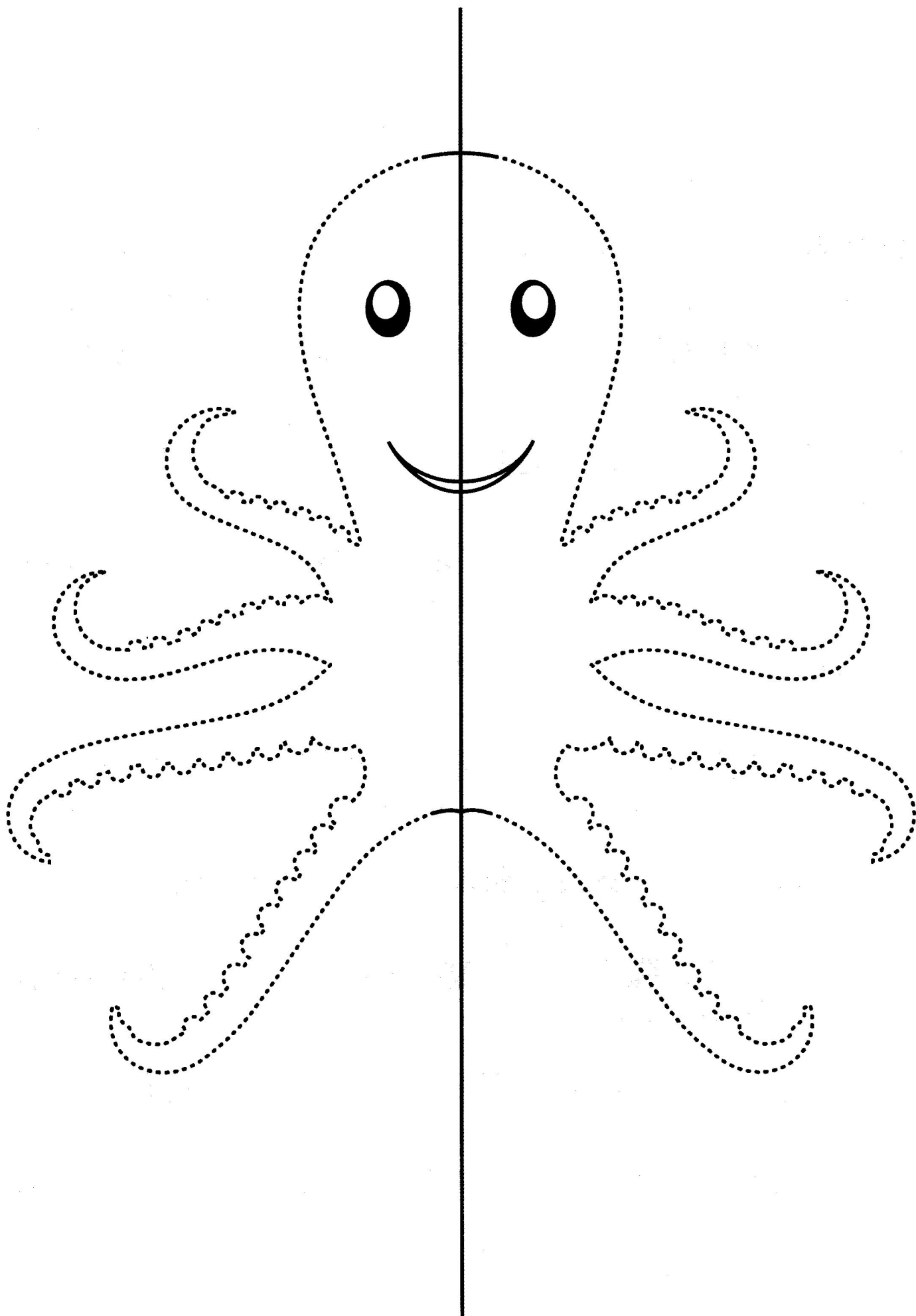

ЛЕВАЯ

ПРАВАЯ

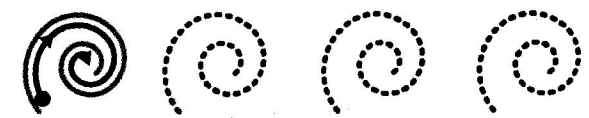
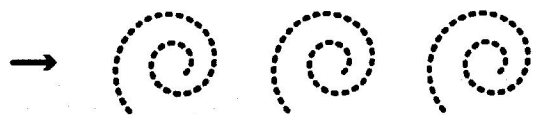
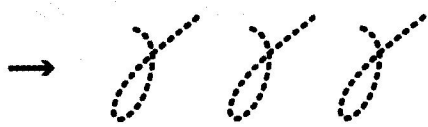
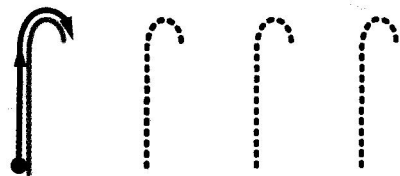
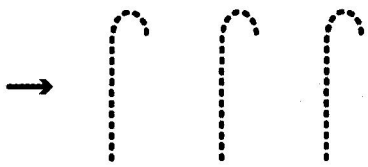
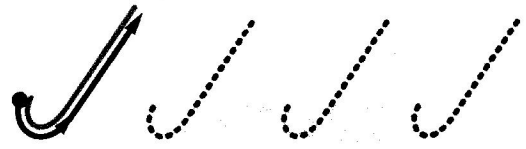
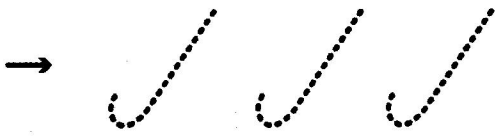
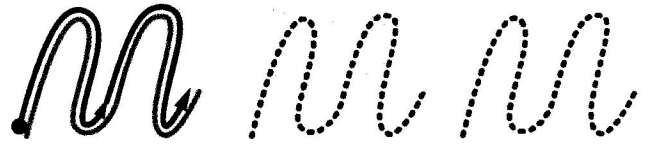
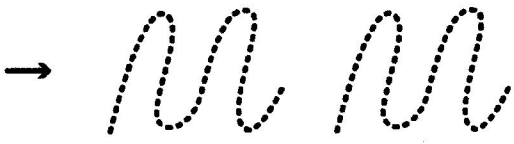

ЛЕВАЯ

ПРАВАЯ

→ y y y

y y y y

→ e e e e

e e e e

→ o o o

o o o o

→ b b b

b b b b

→ t t t

t t t t

→ ∞ ∞ ∞

∞ ∞ ∞ ∞

→ 7 7 7

7 7 7 7

→ 8 8 8

8 8 8 8

→ J J J

J J J J

ЛЕВАЯ

ПРАВАЯ

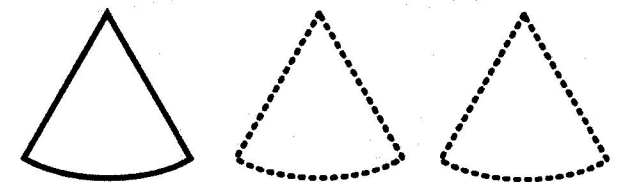
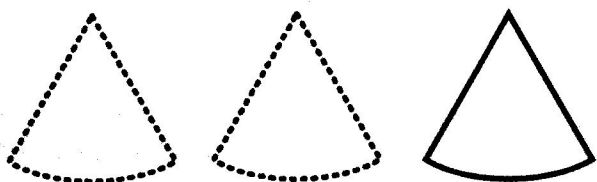
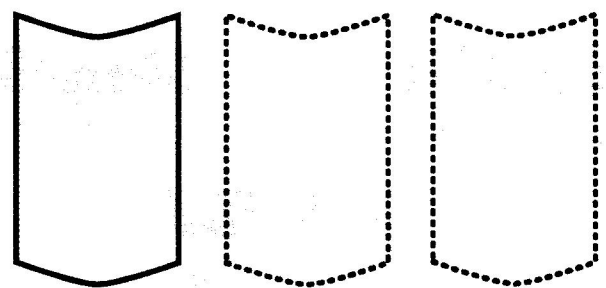
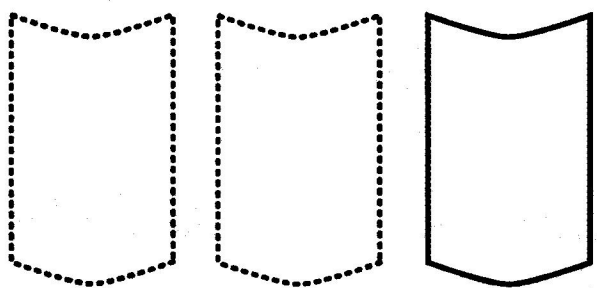
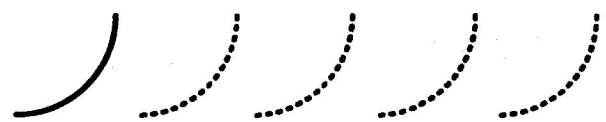
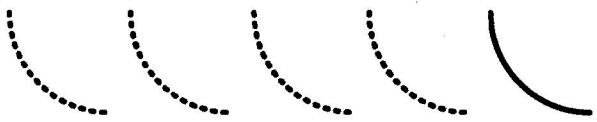
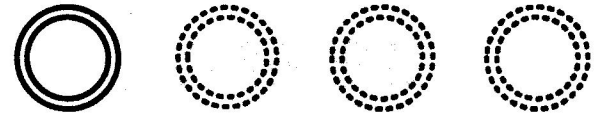
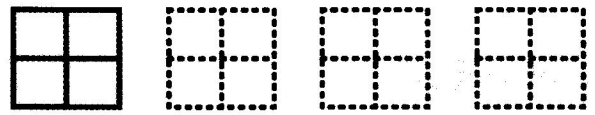
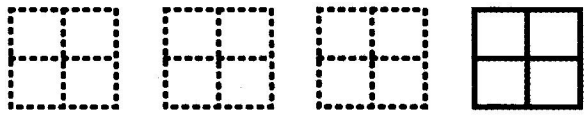

ЛЕВАЯ

ПРАВАЯ

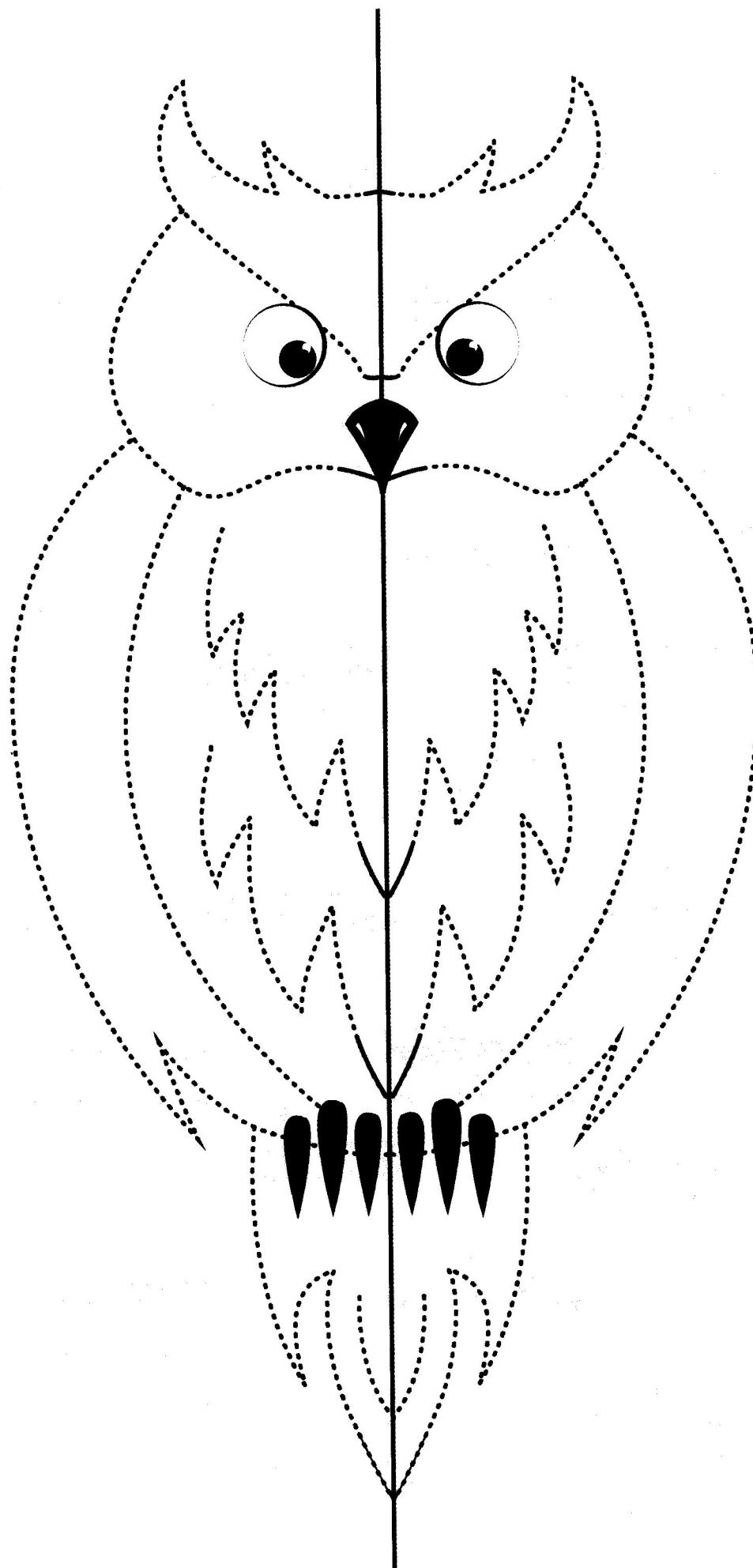

ЛЕВАЯ

ПРАВАЯ

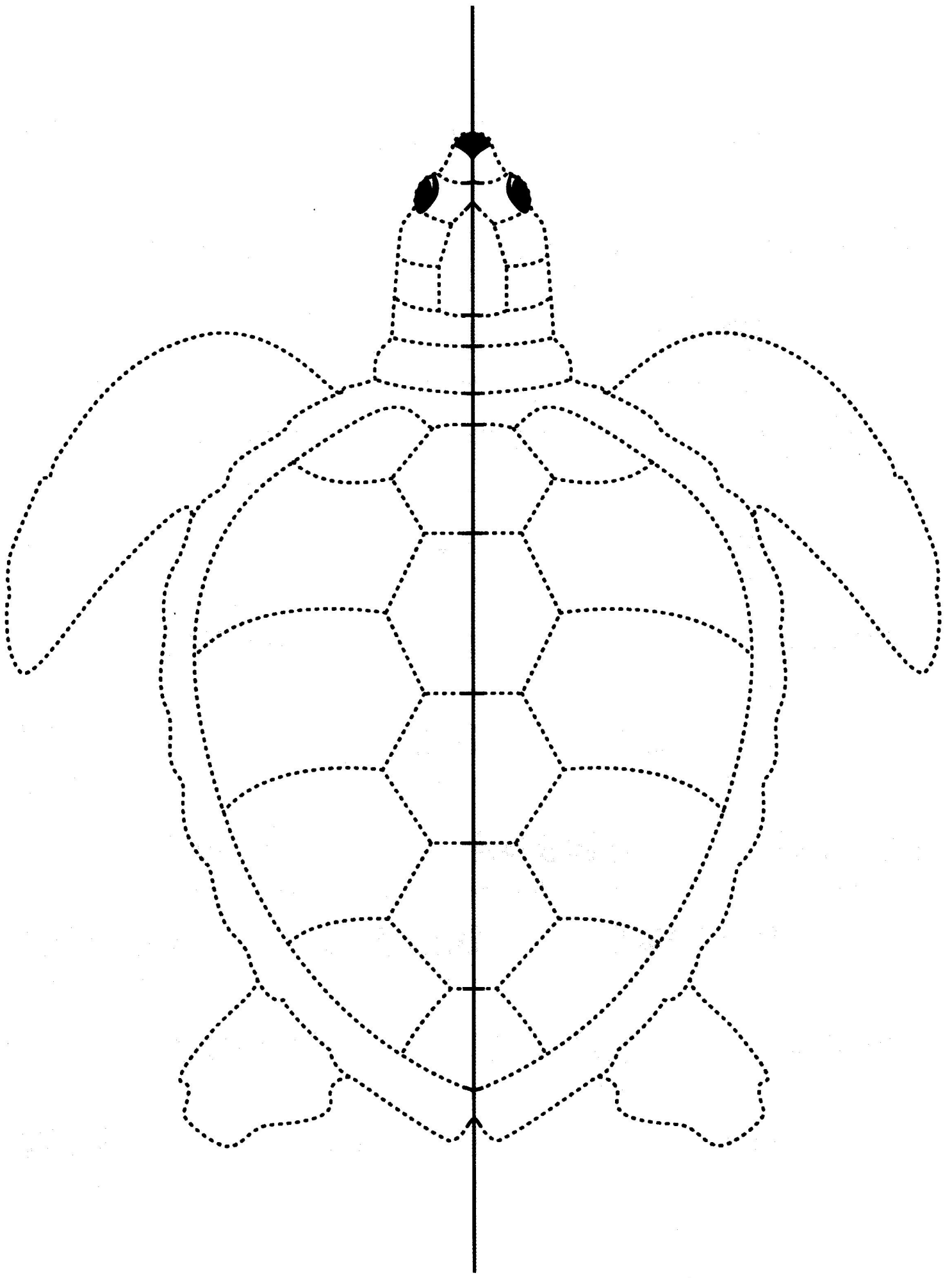

ЛЕВАЯ

ПРАВЯЯ

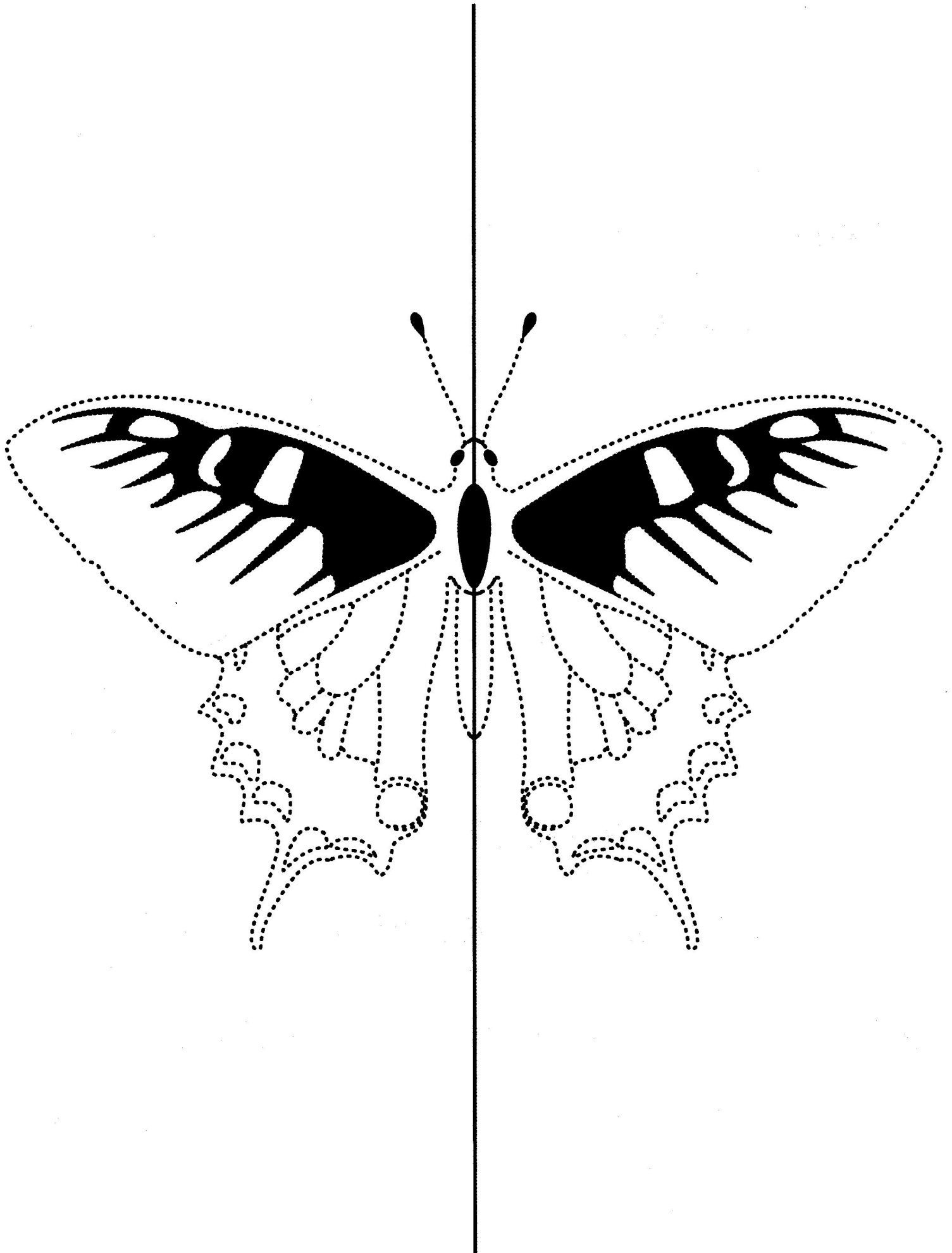

ЛЕВАЯ

ПРАВАЯ

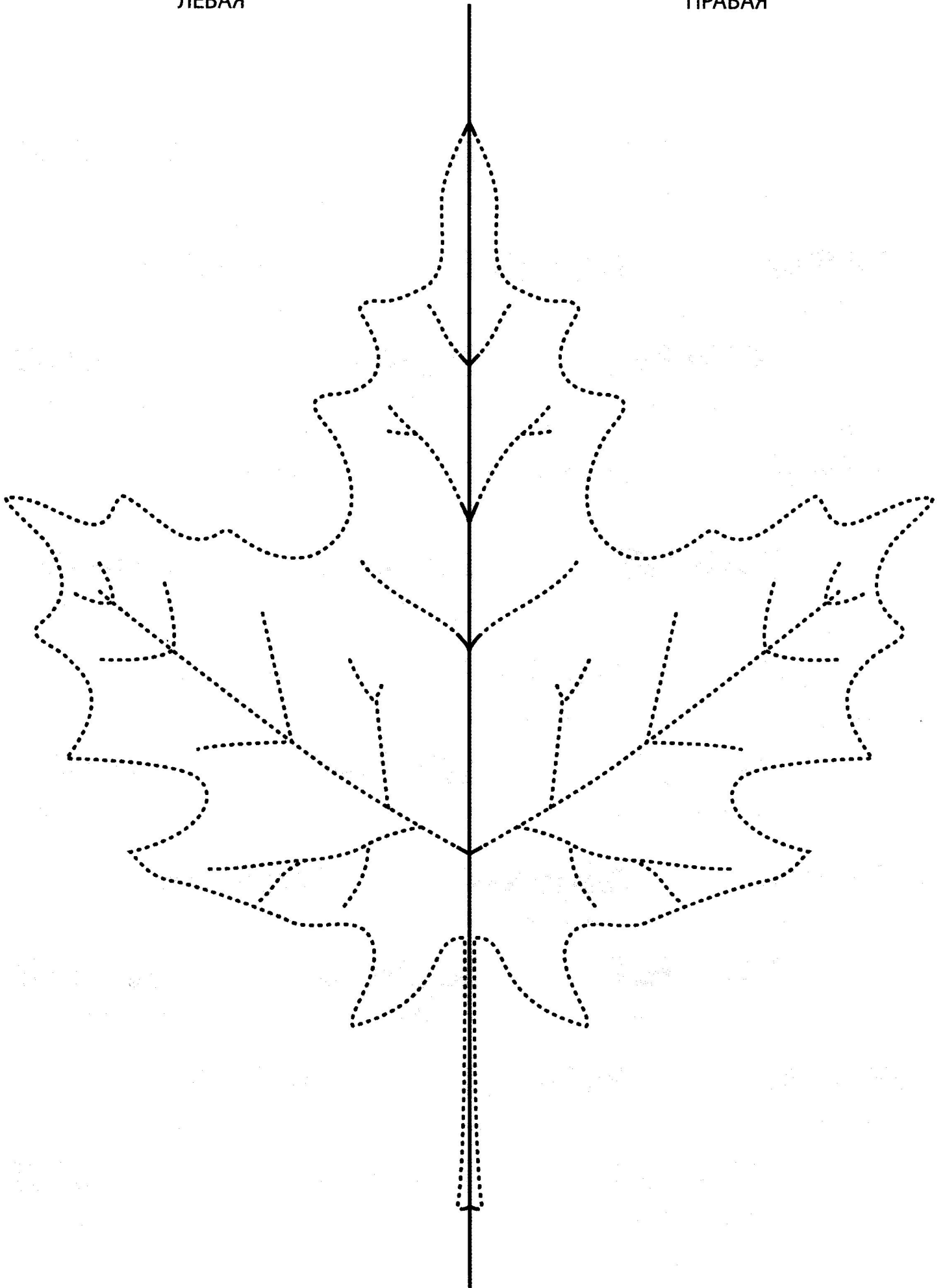

ЛЕВАЯ

ПРАВАЯ

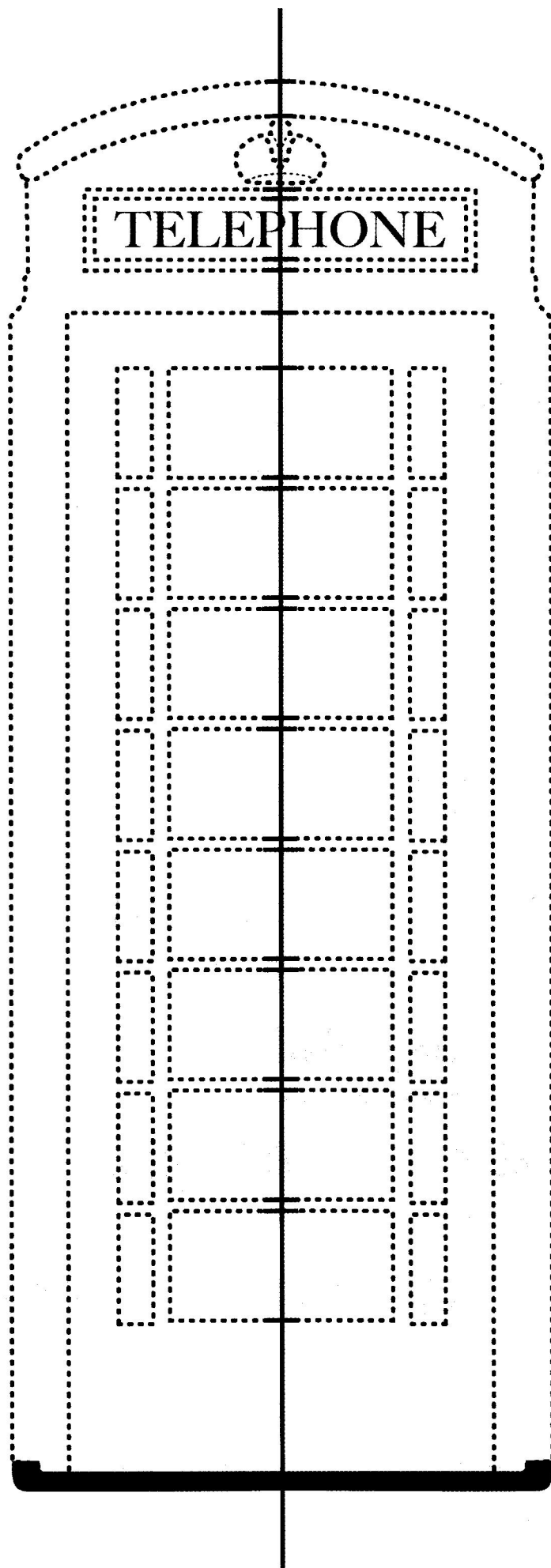

ЛЕВАЯ

ПРАВАЯ

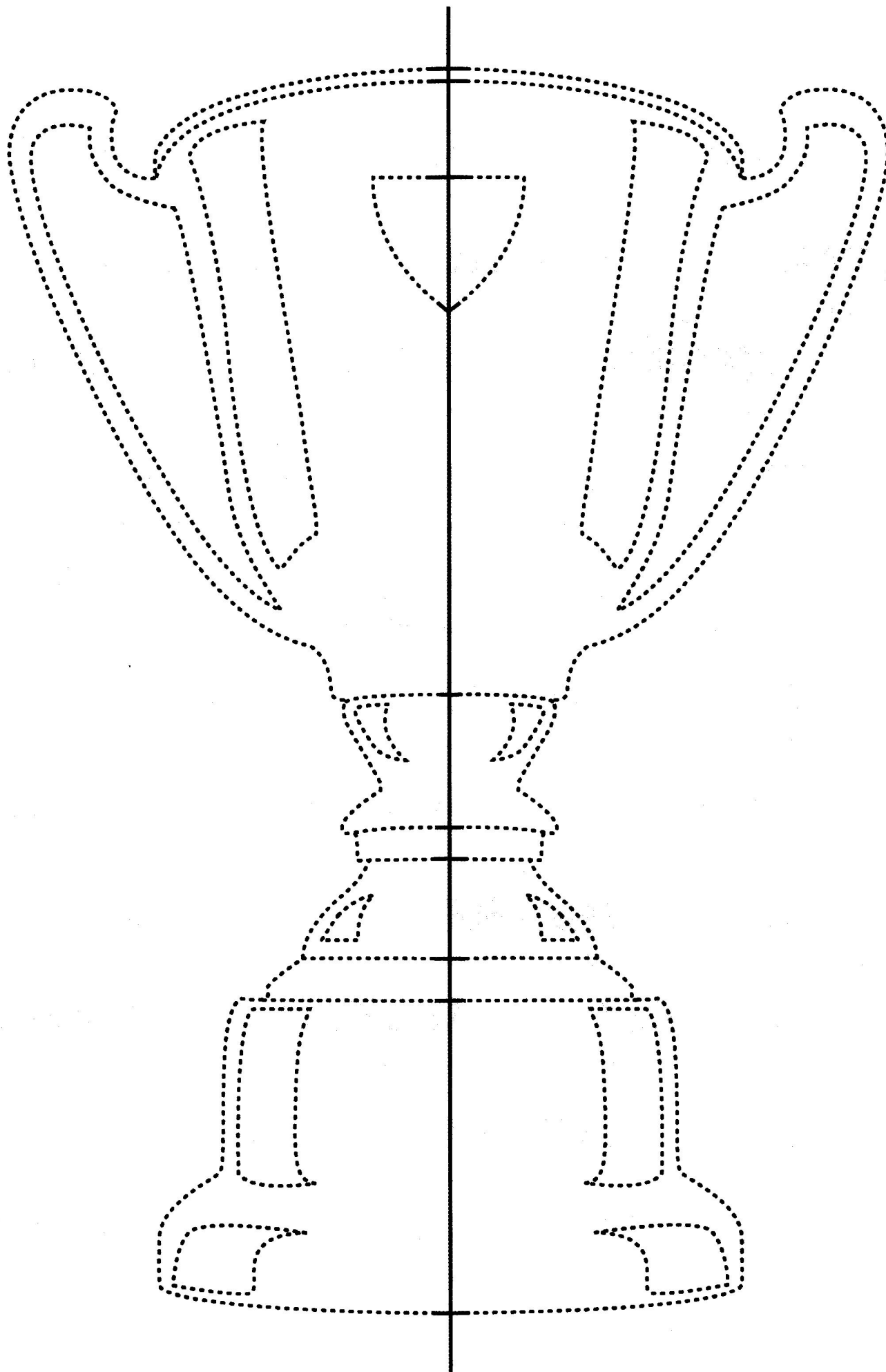

ЛЕВАЯ

ПРАВАЯ

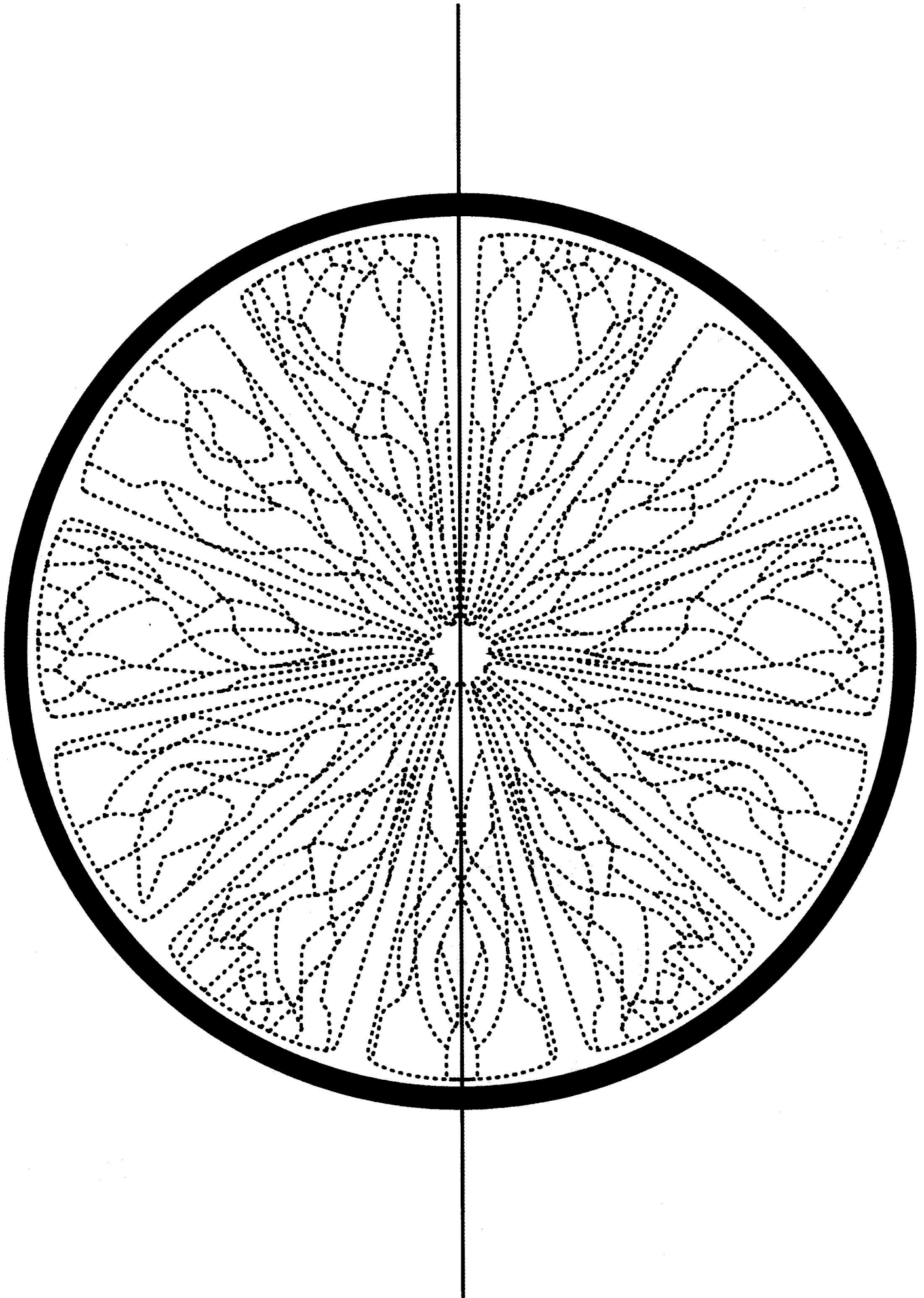

ЛЕВАЯ

ПРАВАЯ

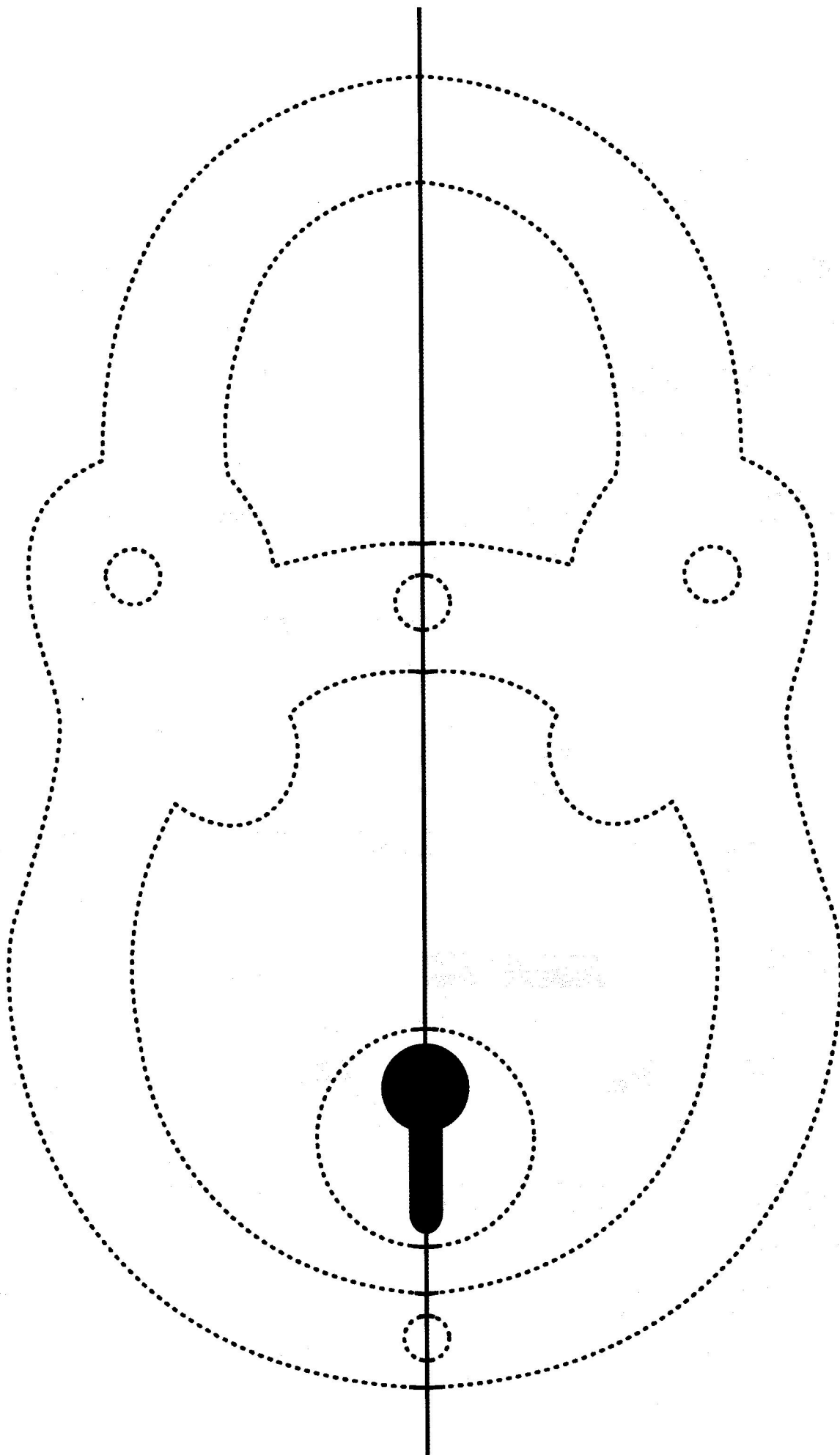

ЛЕВАЯ

ПРАВАЯ

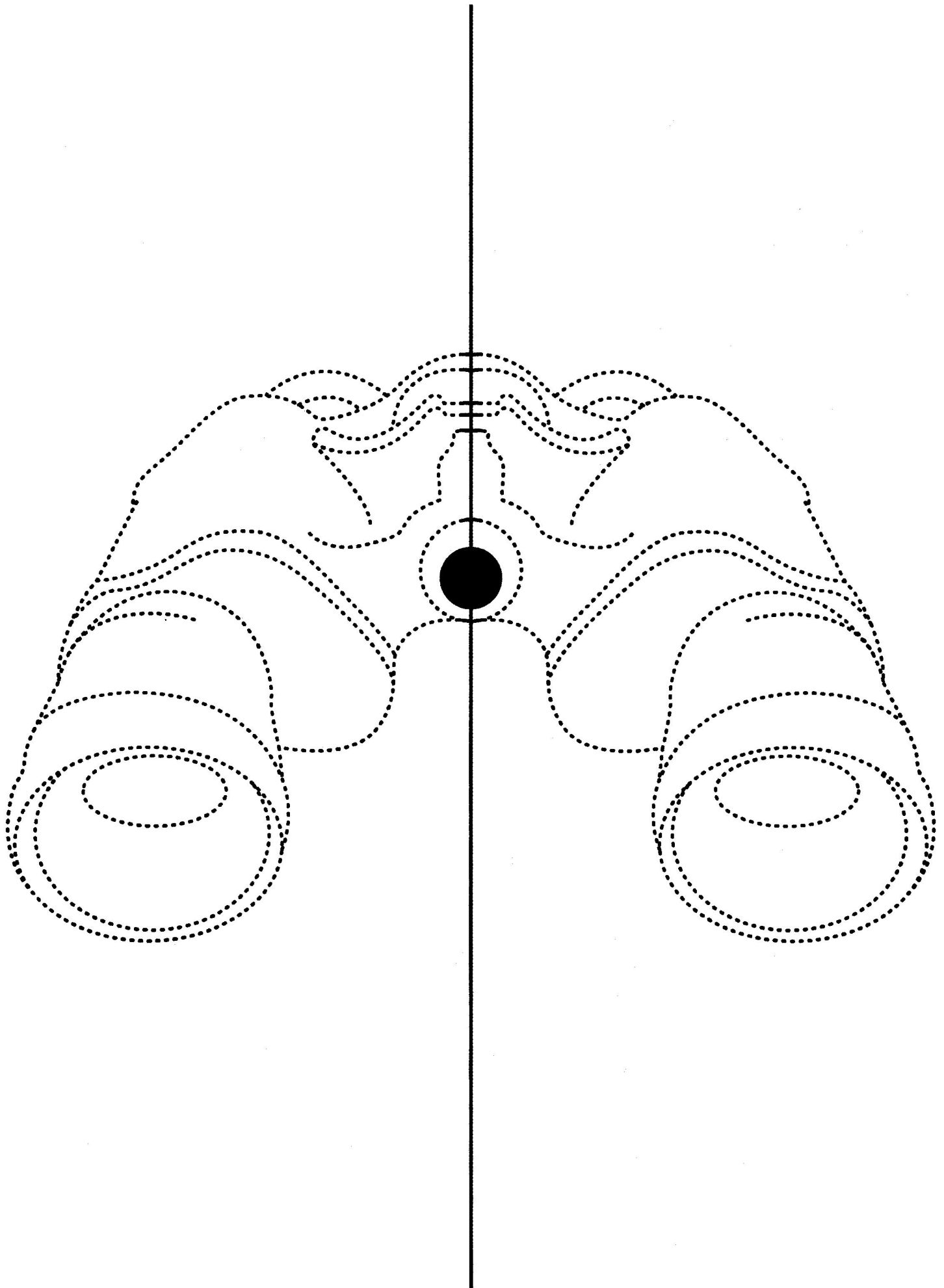

ЛЕВАЯ

ПРАВАЯ

